

IMPORTANT SAFEGUARDS

When using electrical appliances, especially when children are present, basic safety precautions should always be followed, including the following:

READ ALL INSTRUCTIONS BEFORE USING.

KEEP AWAY FROM WATER.

DANGER: As with most electrical appliances, electrical parts are electrically live even when the switch is off.

To reduce the risk of death by electrical shock:

1. Always "unplug it" immediately after using.
2. Do not use while bathing, in damp rooms, or over a hand basin or vessel filled with water.
3. Do not place or store appliance where it can fall or be pulled into tub or sink.
4. Do not place in or drop into water or other liquid.
5. If an appliance falls into water, "unplug it" immediately. Do not reach into the water.
6. Never use the appliance with wet hands. Never immerse appliance in water. Never hold this appliance under running water or allow it to become wet (as in splashing).

WARNING: To reduce the risk of burns, electrocution, fire, or injury to persons:

1. Do not leave appliance unattended while it is operating or is plugged in.
2. Close supervision is necessary when this appliance is used by, on, or near children or invalids.
3. Use this appliance only for its intended use as described in this manual. Do not use attachments not recommended by the manufacturer.
4. Never operate this appliance if it has a damaged cord or plug, if it is not working properly, if it has been dropped or damaged in any manner or dropped into water. Contact Consumer Service for examination and repair or mechanical adjustment.
5. Keep the cord away from hot or heated surfaces. Do not wrap the cord around the appliance.
6. Never use while sleeping or while drowsy.

7. Never drop or insert any object into any opening.
8. Do not use outdoors or operate where aerosol (spray) products are being used. Do not operate where oxygen is being administered.
9. Place unit on a level surface to use. Do not use on a bed or any soft surface where unit could tip over easily or be covered up.
10. Connect this appliance to a properly grounded outlet only.
11. Unit is hot when in use. To avoid burn hazard, do not touch the hot plates, they are hot.
12. Do not use an extension cord with this appliance.
13. Do not leave an Adaptor Plug in wall outlet when not in use.
14. Most foreign countries have unstable voltage which may cause your appliance to shut off due to irregular voltage. This does not harm the appliance, or indicate a defective product.
15. Before plugging in, read the information about dual voltage contained in the instruction section of this manual.

SAVE THESE INSTRUCTIONS

THIS PRODUCT IS FOR HOUSEHOLD USE ONLY
THE STRAIGHTENER IS NOT A TOY.

ADDITIONAL IMPORTANT SAFEGUARDS

1. This Straightener and its Straightening Plates are hot when in use. Do not let eyes or bare skin touch heated surfaces.
2. Keep fingers out of the Pivot Area.
3. Do not over straighten the hair.
4. Do not use on damaged hair.
5. Do not use styling products in the hair prior to straightening.
6. Do not remove Straightening Combs while the Straightener is ON.
7. Begin straightening hair 1/2 inch away from the scalp.

NOTE: Use on dry hair only. Do not use this appliance on synthetic hair wigs.

WARNING: Please keep the cord away from hot metal surfaces.

Polarized Plug

This appliance has a polarized plug (one blade is wider than the other.) To reduce the risk of electric shock, this plug is intended to fit into a polarized outlet only one way. If the plug does not fit fully in the outlet, reverse the plug. If it still does not fit, contact a qualified electrician. Do not attempt to defeat this safety feature.



KEEP AWAY FROM CHILDREN

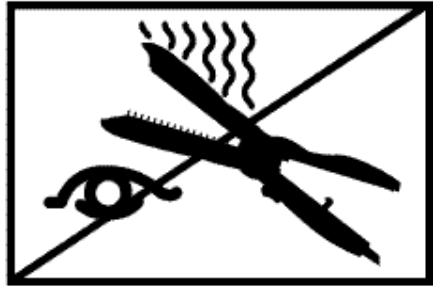

CAUTION - THIS PRODUCT CAN BURN EYES

Getting to Know Your COMPACT FOLD-AWAY Straightener

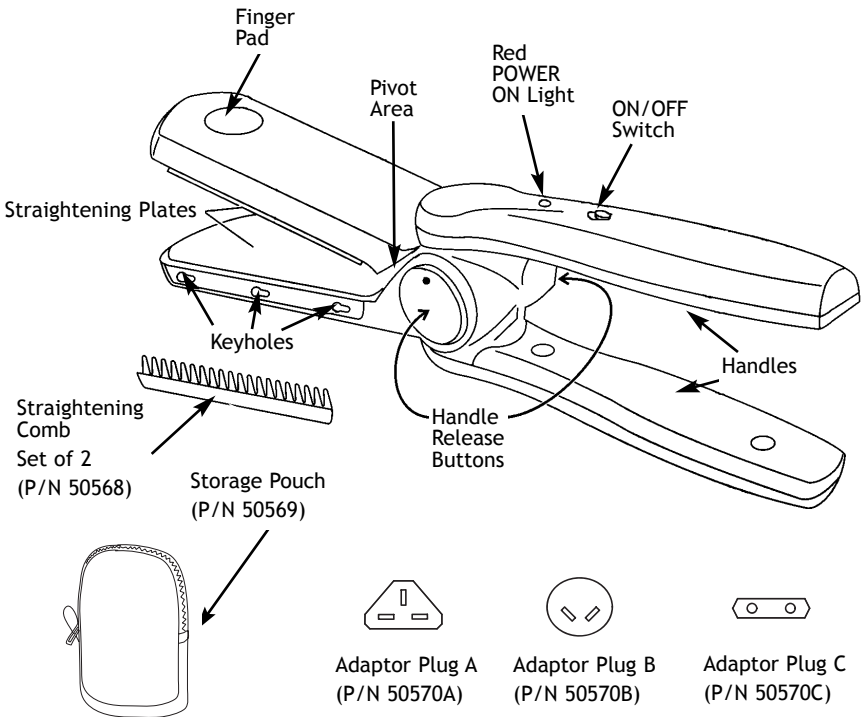

OPERATING THE COMPACT FOLD-AWAY STRAIGHTENER

When used correctly, the Fold-Away Straightener will help you to achieve the latest fashionable styles. With this salon-quality tool, you will be able to style your hair from curly to sleek and straight in no time!

BEFORE STYLING THE HAIR

IMPORTANT: Before styling, ensure that the hair is clean, dry and tangle-free.

We do not recommend using styling products in the hair prior to straightening. Some products are flammable and will cause the hair to stick to the Straightening Plates. Build up from products will coat the Straightening Plates and prevent the hair from passing through smoothly. Use styling/shine products after the hair is straightened.

Attention: You may notice a metallic smell the first time using the Straightener, this is normal and will cease with use.

DUAL VOLTAGE: This appliance utilizes a positive temperature coefficient (PTC) heating element and operates over a range of voltages.

Confirm the voltage available at each location before using the appliance.

For connection to a 240-volt supply or above, use an attachment plug adaptor of the proper configuration for the power supply receptacle.

FOLD-AWAY STRAIGHTENER OPERATION

CAUTION: Do not rest Straightener on its side.

CAUTION: NEVER leave the Straightener ON and unattended.

WARNING: Finger Pads may become hot during use. Do not touch for long periods of time while styling hair.

1. Press both Handle Release buttons.
2. Turn the Handle facing you in the direction of the "OPEN" arrow.
3. Keep turning Handle until it locks into place.

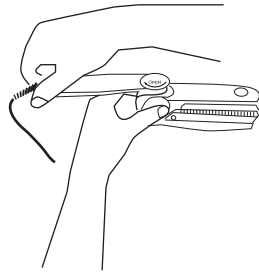

4. Repeat steps 2 and 3 for opposite Handle.
5. Plug the Power Cord into an AC electrical outlet.
6. Slide the ON/OFF Switch to the ON position. The red POWER ON Light will illuminate.
7. It will take approximately 2 minutes for the Straightener to heat up.
8. Do not force the Straightener through the hair; Take smaller sections.
9. When straightening is complete, slide the ON/OFF Switch to OFF. Unplug unit.

REMOVING OR REPLACING STRAIGHTENING COMBS

1. Slide the ON/OFF Switch to OFF. Unplug unit.
2. Before replacing or removing Combs, allow the Straightener to cool completely.

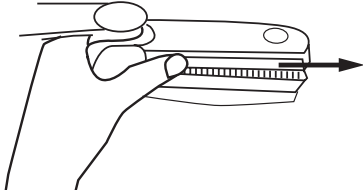

3. There are 2 Straightening Combs included with your hair Straightener. They may be used in any position that works best for you.
 4. There are 3 studs on the inside of each comb and 3 keyhole slots in one side of each of the plates.
 5. To remove a comb, place thumb on top of the end of the comb near the handle and push down and away from the handle. Once it has moved about a quarter of an inch lift the comb out.
 6. To replace a comb, fit the studs through the large ends of the keyholes and slide the comb towards the handles. The rounded end of the comb fits closest to the Handle end of the Plate while the pointy end of the comb should be towards the open end of the Plate.
- Note:** Make sure combs are firmly in place.
7. If small sections are being used and it is difficult to glide the Straightener through the hair, the Straightening Combs may be removed for ease of use.

STYLING TIPS

Timing

1. The Straightener uses a ceramic PTC heating element for fast heat-up and constant temperature. You will need to test how long it takes to straighten your hair from the roots to the ends.
2. First test an inconspicuous section of your hair. Use thinner sections for thick, resistant hair.
3. **Begin timing at 5 - 8 seconds for fine, thin hair. Straighten for 10 - 15 seconds for thick or coarse hair.** Slide the Straightener from the root area sliding to the ends of the hair. If more time is needed, skip to a new section of hair until you find the right time needed.
4. If hair requires a second pass to straighten, **use less time** for the second pass.

Steam

1. If product build up is on the hair, or a conditioner has been used, you will notice a slight amount of steam coming from the Straightener. This is normal.
However, if large amounts of steam are forming, discontinue straightening. Press the ON/OFF Switch to OFF and unplug the unit.
2. Wash your hair with a clarifying shampoo to remove the build-up. Condition hair with a light conditioner as necessary, and dry the hair thoroughly.
3. Proceed in straightening hair.

Steaming or Singeing?

When the hair is steaming, there will be a slight product odor and white steam— this is normal. When the hair is singeing, there will be a strong odor and light to dark "smoke". You can tell the hair is overly straightened when the hair frizzes and possibly discolors.

Frazzled Hair



Over-straightening can frazzle hair!
The hair will appear smooth, but some strands will form kinks, unlike the natural curl of the hair.

This is the first sign of hair damage.
Discontinue straightening immediately.

WARNING: DO NOT TRY TO STRAIGHTEN DAMAGED HAIR!

Chemically Treated Hair

1. Use CAUTION when straightening chemically treated, colored, or permed hair.
2. Cut down the time used for straightening chemically treated, colored, or permed hair.
3. Smaller sections are better for thick or resistant hair.

STYLING

1. Divide hair into sections before starting.
2. Consult STYLING TIPS for proper Timing before straightening.
3. Section hair and begin straightening in the back nape area.

4. Take a 2 inch wide and 1 inch thick section and place between the open Straightening Plates (1/2 inch away from scalp).

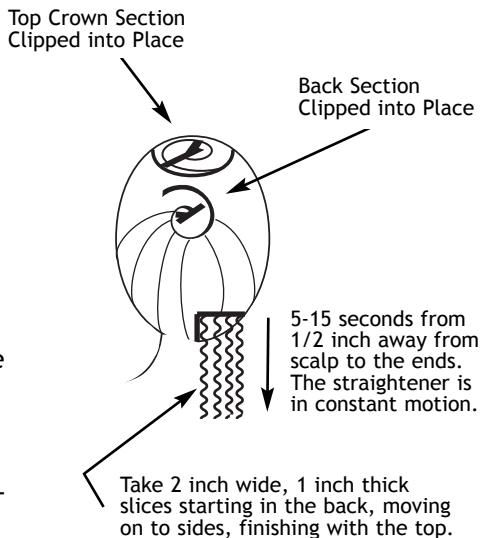
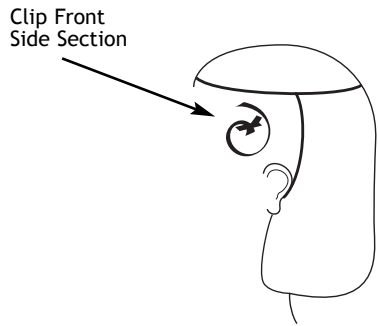
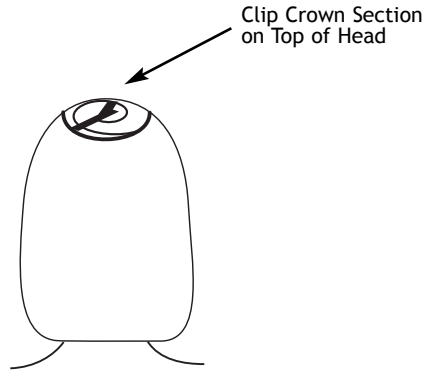

5. Squeeze the Handles together to close the Straightening Plates and gently slide the Straightener through the hair towards the end within the designated time, roots to ends (5-15 seconds).



CAUTION: You must keep the Straightener moving while straightening to avoid hair damage.

6. If hair requires a second pass to straighten, use less time for the second pass. Do not repeat straightening for extended periods of time as hair is delicate.
7. The hair will be very hot, allow to cool before touching. Do not comb or brush through the hair to allow the hair to "set in".
8. Work your way up, going on to the sides and finishing with the top crown area.
9. How fast or slow you move the Straightener will have an effect on the end results.

For a Straight Look

Move the Straightener through the hair, when you get towards the ends of the hair pull the Straightener parallel to the section you made at the scalp.

For a Rounded Look

Move the Straightener through the hair, when you get towards the ends of the hair, position the Straightener so that it rounds the hair under.

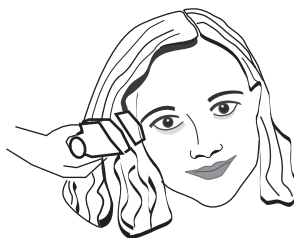

INSTRUCTIONS FOR ADAPTOR PLUG USE

1. Check wall outlet to determine shape of Adaptor Plug needed
2. Make sure unit is OFF before proceeding.
3. Plug the appropriate Adaptor Plug into wall outlet.
4. Insert Fold-Away Straightener plug into Adaptor Plug and slide the ON/OFF Switch to the ON position.
5. When straightening is complete slide the ON/OFF Switch to the OFF position.
6. Unplug the Adaptor and Straightener Plugs from wall outlet and allow the unit to cool.

USER MAINTENANCE INSTRUCTIONS

This appliance requires little maintenance. It contains no user serviceable parts. Do not try to repair it yourself. Contact a qualified appliance repair technician if the product requires servicing.

Cleaning

1. The Straightener must be completely cooled and unplugged before cleaning.
2. Wipe the Straightener with a damp cloth. Do not use cleaning solutions on Straightener or Straightening Plates.
3. For stubborn product build up on Straightening Plates, dampen cloth with warm water and rub off. Do not use sharp-edged metal tools or abrasive cleaning pads as they will scratch the surface of the Straightening Plates.
4. Make certain the Straightener is completely dry before using. Keep heated surfaces of the Straightener clean and free of dust, dirt, and styling products.

Storage

NOTE: When not in use, make sure the Straightener is unplugged.

1. Slide the ON/OFF Switch to the OFF position. The red POWER ON Light will turn off.
2. Unplug the Power Cord from the electrical outlet.
3. Allow the appliance to cool completely. Once the Straightener is cooled, fold up the Handles by pressing in both Handle Release buttons and turning Handles in the direction of the "CLOSE" arrows until they are locked in position for compact storage.
4. Store in a cool, dry location.
5. Never wrap the power cord around the Straightener, as this will cause the cord to wear prematurely and break. Check the power cord for wear and damage regularly, particularly where the cord enters the appliance and the plug.

CAUTION: If the cord of this appliance becomes damaged, refer to the Service and Repair section of the warranty.

REPLACEMENT PARTS

Replacement parts are available, and may be purchased through our Consumer Relations Department by calling 1-800-934-7455, Mon-Fri. 9am-5pm Central Time, with Visa, Mastercard, Discover, or American Express. Please be ready to give the part number(s) when you call.

Or log into our website to order at: www.eSalton.com

ANDREW COLLINGE Fold-Away Straightener (AC8TST & AC8TSTG)

REPLACEMENT PARTS

<u>PART #</u>	<u>DESCRIPTION</u>
50568	Straightening Combs (Set of 2)
50569	Storage Pouch
50570A	Adaptor Plug A
50570B	Adaptor Plug B
50570C	Adaptor Plug C

NOTES

LIMITED ONE YEAR WARRANTY

Warranty: This Scunci product is warranted by Salton, Inc. to be free from defects in materials or workmanship for a period of (1) year from the original purchase date. This product warranty covers only the original consumer purchaser of the product.

Warranty Coverage: This warranty is void if the product has been damaged by accident in shipment, unreasonable use, misuse, neglect, improper service, commercial use, repairs by unauthorized personnel, normal wear and tear, improper assembly, installation or maintenance abuse or other causes not arising out of defects in materials or workmanship. This warranty is effective only if the product is purchased and operated in the USA, and does not extend to any units which have been used in violation of written instructions furnished with the product or to units which have been altered or modified or to damage to products or parts thereof which have had the serial number removed, altered, defaced or rendered illegible.

Implied Warranties: ANY IMPLIED WARRANTIES WHICH THE PURCHASER MAY HAVE ARE LIMITED IN DURATION TO ONE (1) YEAR FROM THE DATE OF PURCHASE. Some states do not allow limitations on how long an implied warranty lasts, so the above limitation may not apply to you.

Warranty Performance: During the above one-year warranty period, a product with a defect will be either repaired or replaced with a reconditioned comparable model (at our option) when the product is returned to the Repair Center, or the purchase price refunded. The repaired or replacement product will be in warranty for the balance of the one-year warranty period and an additional one-month period. No charge will be made for such repair or replacement.

Service and Repair: Should the appliance malfunction, you should first call toll-free 1 (800) 934-7455 between the hours of 9:00 am and 5:00 pm Central Standard Time and ask for CONSUMER SERVICE stating that you are a consumer with a problem. Please refer to model number S73051 when you call.

In-Warranty Service (USA): For an appliance covered under the warranty period, no charge is made for service or postage. Call for return authorization 1 (800) 934-7455.

Out-of Warranty Service: A flat rate charge by model is made for out-of-warranty service. Include \$ 8.00 (U.S.) for return shipping and handling. We will notify you by mail of the amount of the charge for service and require you to pay in advance for the repair or replacement.

For Products Purchased in the USA, but Used in Canada: You may return the product insured, packaged with sufficient protection, and postage and insurance prepaid to the USA address listed below. Please note that all customs duty/brokerage fees, if any, must be paid by you and we will require you to pay the cost of customs duty/brokerage fees to us in advance of our performing any service.

Risk During Shipment: We cannot assume responsibility for loss or damage during incoming shipment. For your protection, carefully package the product for shipment and insure it with the carrier. Be sure to enclose the following items with your appliance: any accessories related to your problem, your full return address and daytime phone number, a note describing the problem you experienced, a copy of your sales receipt or other proof of purchase to determine warranty status. C.O.D. shipments cannot be accepted.

To return the appliance, ship to:

ATTN: Repair Center
Salton, Inc.
708 South Missouri Street
Macon, MO 63552

To contact us, please write to, call, or email:

Salton, Inc.
P.O. Box 1637
Columbia, MO 65205-7366
1 (800) 934-7455
E-mail: Salton@Saltonusa.com

Limitation of Remedies: No representative or person is authorized to assume for Salton, Inc. any other liability in connection with the sale of our products. There shall be no claims for defects or failure of performance or product failure under any theory of tort, contract or commercial law including, but not limited to negligence, gross negligence, strict liability, breach of warranty and breach of contract. Repair, replacement or refund shall be the sole remedy of the purchaser under this warranty, and **in no event shall Salton be liable for any incidental or consequential damages, losses or expenses.** Some states do not allow the exclusion or limitation of incidental or consequential damages, so the above limitation or exclusion may not apply to you.

Legal Rights: This warranty gives you specific legal rights, and you may also have other rights which vary from state to state.

For more information on Salton products: visit our website: www.eSalton.com

©2003 Salton, Inc. All rights reserved.
Made in China

P/N XXXXX
Printed in China